



UCM-1 MOD ONLY

ATTACH TYPE

ATTACH UCM-1 MOD ONLY

LIVE CIRCUITS

LIVE CIRCUITS

WARNING!!

WARNING!!

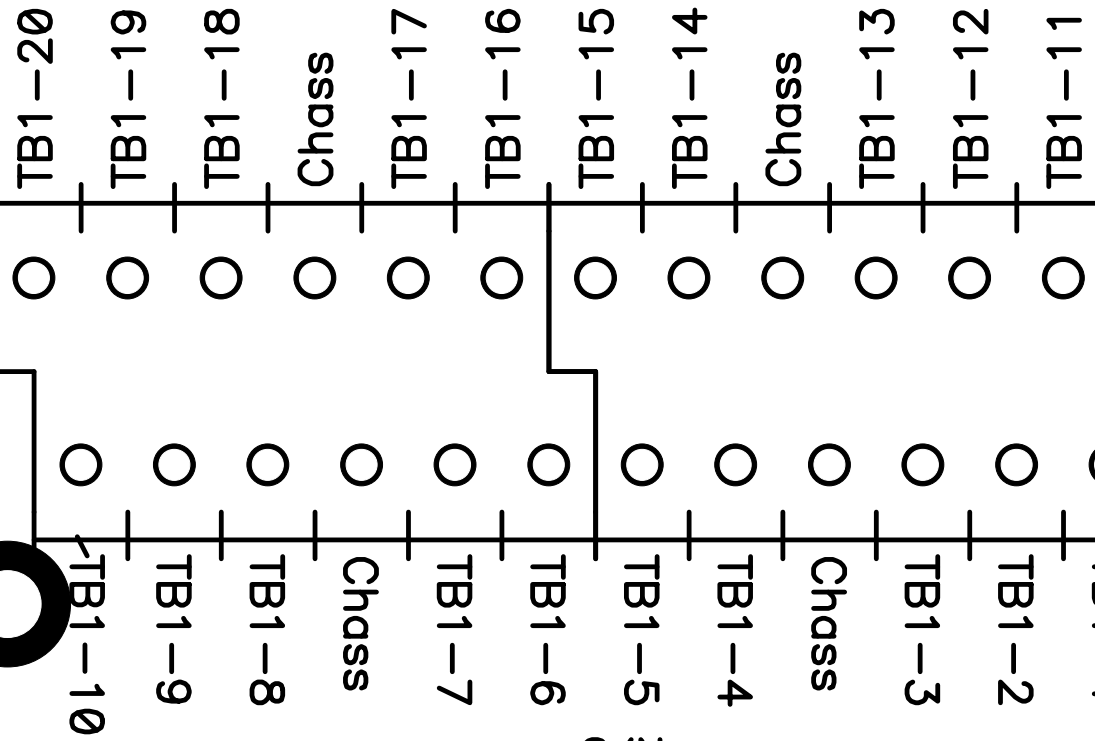
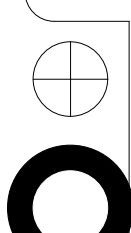
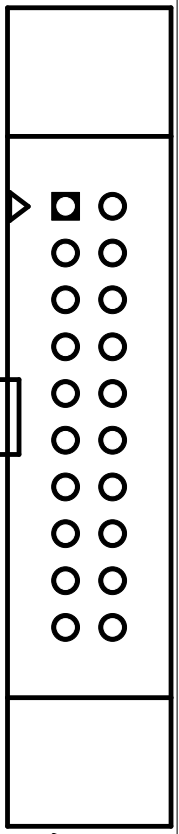
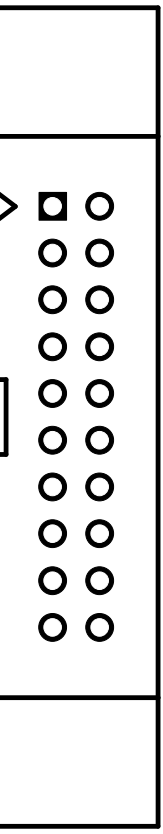
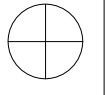
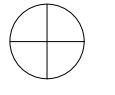
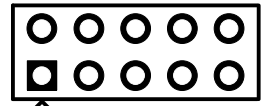
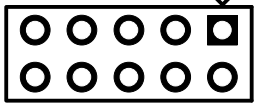

N/S